

Brand products discounted UP TO 60% OFF

SMART HOME LIFE

DON'T MISS THEM>>



Multi-language search available

SEARCH

CART

Led Bulb, Xiaomi, DOOGEE, Arduino, Sandisk, Xiaomi Mi Band 2

ALL DEPARTMENTS

New Arrivals

\$0.99

Top Sellers

Extreme Deals

Community

MVP

DX » Electrical & Tools » Arduino & SCM Supplies » Sensors

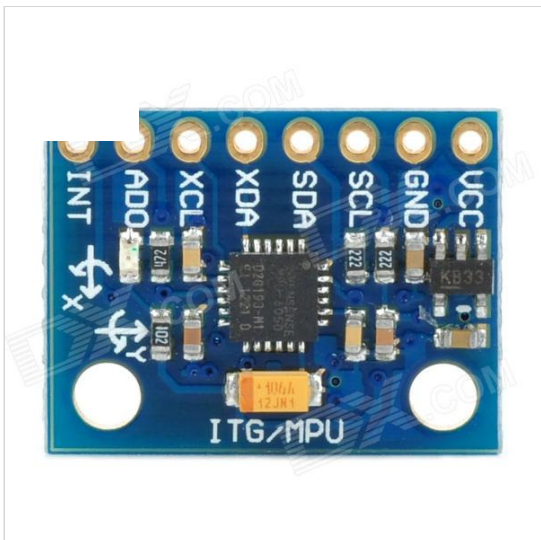

### Three Axis Gyroscope Accelerometer Sensor Module for Arduino (Works with Official Arduino Boards)

(6 reviews) | SKU: 148615 (Added on 15/08/2012)

List Price: CHF13,97 **76% OFF**

Price: **CHF 3,34**

Shipping: To SWITZERLAN

Quantity:  **ADD TO CART**

100% Satisfaction guaranteed or Your money back

Price Match

Report Error

Product Details | Reviews | Discussions

415



Overview

Specifications

Buy 3+ and Save

Reviews

<b>Model</b>	I072605
<b>Quantity</b>	1
<b>Material</b>	PCB
<b>Features</b>	Chip: MPU-6050; Power supply: 3~5V; Means of communication: IIC communication protocol; Chip built-in 16 bit AD adapter; Gyroscope range: +/- 250 500 1000 2000 degree/s; Pin pitch: 2.54mm
<b>Application</b>	Great for cellphone / game device / 3D remote controller
<b>Packing List</b>	1 x Module 1 x Curved needle 1 x Straight needle

## Three Axis Gyroscope Accelerometer Sensor Module

For Arduino (Works with Official Arduino Boards)

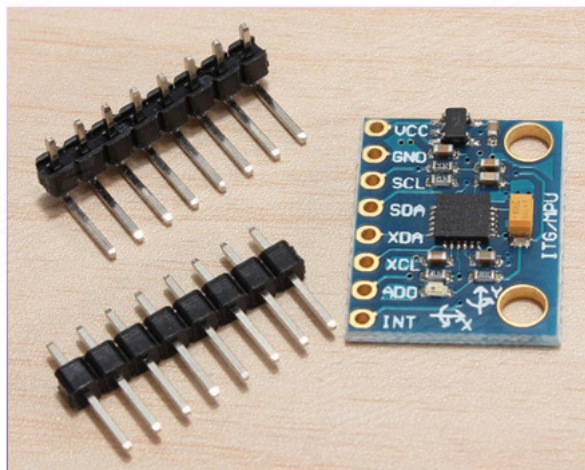

A	<h3>Features</h3> <p>MPU-6050 Accelerometer + Gyro The MPU-6050 sensor contains a MEMS accelerometer and a MEMS gyro in a single chip. It is very accurate, since it contains 16-bits analog to digital conversion hardware for each channel. Therefore it captures the x, y, and z channel at the same time.</p>	<h3>Specification</h3> <p>Use Chip: MPU-6050 Power supply: 3-5V (Internal low dropout regulator) Communication: IIC communication protocol standard 16bit AD converter-chip, 16-bit data output Gyro Range: ± 250 500 1000 2000 °/s Acceleration range: ± 2 ± 4 ± 8 ± 16g Using Immersion Solder PCB, welding machines to ensure quality</p>	B
C	<h3>Application</h3> <p>Motion sensing games Augmented Reality Electronic image Stabilization (ES: Electronic image Stabilization) Optical Image Stabilization (OIS: Optical image Stabilization) "Zero-touch" gestures User Interface Pedestrian navigation Gesture shortcuts</p>	<h3>Market</h3> <p>Smart phone Tablet device Handheld games 3D remote controller Portable navigation devices</p>	D

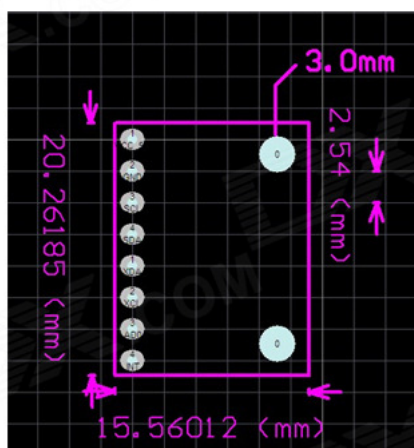
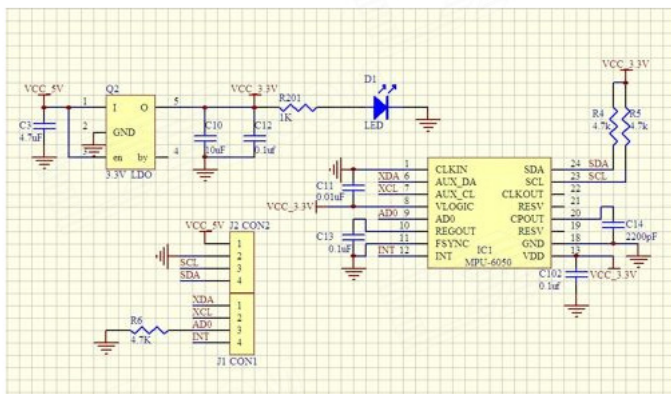

Dimensions: 0.79 in x 0.59 in x 0.08 in (2.0 cm x 1.5 cm x 0.2 cm)  
Weight: 0.74 oz (21 g)

All packages from DX.com are sent without DX logo or any information indicating DX.com. Due to package variations from suppliers, the product packaging customers receive may be different from the images displayed.

To enable volume discounts on this site, use coupon code: BULKRATE during checkout. You will see a discount applied at the bottom of the shopping cart. Competitive pricing is available. Contact us for details.





Quantity	3+ units	5+ units	10+ units
Rate	CHF2,96 shipped	CHF2,95 shipped	CHF2,94 shipped

**What is Bulk Rate?** BulkRate is a semi-wholesale system with items priced separately from retail. When you use bulk rates, a flat \$1.70 registered air mail fee will automatically be added to your cart to ensure delivery of package. While BulkRate's intention is to offer cheaper prices when you buy in bulk, because it is priced separately it on occasions show a higher than retail price. That's why we ask you to enter BULKRATE as a coupon code to manually activate the rates. You can always opt not to use the bulk rates. If you are looking for wholesale prices please feel free to [contact us](#).

Looking to get even more?

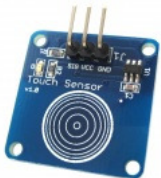
Try **VolumeRate**

Customers Who Viewed This Item Also Viewed

				
<b>DS18B20 Temperature Sensor - Black + Silver</b> <b>CHF1,76</b> (37 Reviews)	<b>Produino Jog-type Touch Sensor Capacitive Touch Switch Module for Arduino -</b> <b>CHF1,49</b> (2 Reviews)	<b>HYSRF05 Ultrasonic Distance Sensor Module for Arduino</b> <b>CHF2,78</b> (0 Reviews)	<b>HC-SR04 Ultrasonic Sensor Distance Measuring Module</b> <b>CHF1,88</b> (218 Reviews)	<b>Keyestudio TMT6000 Ambient Light Sensor for Arduino - Black + Yellow</b> <b>CHF3,28</b> (0 Reviews)

5,0

Customer's impression:



See all 6 reviews

- Excelent!
- GreatQuality
- slowshipping
- goodseller
- The right one

Create Review

Share your reviews, photos and videos here!

Review Program

Recent Customer Reviews

Excelente!

Navirtual Post on 23/07/2016

Pro: Easy to use, excelent. Cons: The shipping is too slow....

Impression:Excelent!, GreatQuality , goodseller



Very good!

joemakeall Post on 16/06/2015

Very good! It took but arrived!

Impression:slowshipping, GreatQuality , goodseller



Very Good!!!!

tasos45 Post on 28/04/2015

Pros: Perfect for arduino,very good numbers Cons : None Other : Value for money

Impression:slowshipping, GreatQuality



great shop!

ktbalazs Post on 11/03/2015

The shipment was slow, but the quality is very good. I am satisfied with the shop, and i will buy more things from here!

Impression:slowshipping, GreatQuality , goodseller



Great value and product

manuelpeirone Post on 19/11/2014

Pros: It does exactly what is says. It's easy enough to implement. The sensors are really accurate and the board is small enough. Cons: None really.

Impression:The right one

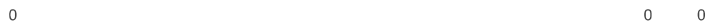

Most Helpful Reviews

Honest IMU...

AhmetOnat Post on 13/01/2014

Works as advertised. Used this as a replacement for my camera stabilizing platform. Works with no problem out of the box, Workmanship is... [Read more](#)



Excelente!

Navirtual Post on 23/07/2016

Pro: Easy to use, excelent. Cons: The shipping is too slow....

Impression:Excelent!, GreatQuality , goodseller



Very good!





joemakeall Post on 16/06/2015

Very good! It took but arrived!

Impression:slowshipping, GreatQuality , goodseller



Customers Who Bought This Item Also Bought

				
<b>IR Infrared Motion Detection Sensor Module (DC 5V~20V)</b> <b>CHF1,93</b> (80 Reviews)	<b>DIY 50Kg Body Load Cell Weighing Sensor Resistance strain Half-bridge Original</b> <b>CHF3,18</b> (1 Reviews)	<b>FC-28-C Soil Moisture Detection Control Module + Soil Humidity Sensor - Blue</b> <b>CHF5,00</b> (4 Reviews)	<b>Portable Electronic Weight Sensor Load Cell Weighing Sensor (1KG)</b> <b>CHF4,48</b> (0 Reviews)	<b>High Precision AM2302 DHT22 Digital Temperature Humidity Sensor</b> <b>CHF7,48</b> (0 Reviews)

Discussions

[See More >](#)

**Post a new topic**

Please note that DealExtreme Forums are not a sales or product support board. For support questions, please contact us via support ticket at <http://cs.dx.com/> for a guaranteed response. We make every effort to make the quickest replies.

Tags of this product

[See More >](#)

Add your tags:  Add

Your last viewed items

[Clear History](#)



Nano V3,0 for Arduino (Works)  
**CHF6,17**



Keys Thumb Joystick Module  
**CHF2,58**



Improved Funduino Mega  
**CHF13,36**

Recommendations Based On Your Recent History



TCST2103 Optical Switch Sensor for Arduino / Raspberry  
**CHF2,90**



GY-BMP280 High Precision Atmospheric Pressure  
**CHF2,62**

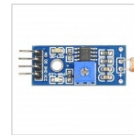

Photo Resistor Sensor Module for DIY - Blue + Black  
**CHF2,17**



Keys Collision Sensor Board - Red + White (Works with)  
**CHF3,28**

Hot Categories

- cheap electrical switches
- best hand tools
- two way radios accessories
- power plug
- walkie talkies on sale
- lithium battery charger
- best electrical tools
- electrical parts
- best lithium batteries
- measurement tool
- electrical gadgets
- arduino board

Hot Products

- sound sensor modules
- color sensor module
- expansion board arduino
- accelerometer arduino
- arduino temperature sensor module
- sensor board
- led module arduino
- humidity sensor module
- display board arduino
- lcd arduino module
- arduino wireless module
- usb module board
- display board module
- arduino relay board
- amplifier module board

# WHY CHOOSE DX.COM?

- Over 300 000 products
- Extremely low prices
- Timely refunds and replacements
- Worldwide free shipping

## Subscribe to our newsletter:



Customer Service Express

- Ticket Service
- Frequently Asked Questions
- Help & Knowledge Base
- Order Tracking

Partner with DX

- Affiliate Program
- Dropship
- Wholesale
- See All

Policy & Information

- About Us
- Privacy Statement
- Conditions of Use
- Site Map

DX Everywhere

- APP
- Mobile Site
- RSS Feed

Follow Us

© 2006~2016 DX.com. All rights reserved.

Note:Stock and Availability shown on this site is for your reference only. While we strive to provide the most accurate and timely stock and availability information, availability information may become out of date and may change between the time you added an item to cart and the time your order is received. Quantities on clearance items are limited. Prices are current at time of posting. DX Reserves the right to change prices at any time without notice.

Partners: DX Wholesale Website | MadeinChina | 寻求供应商



Sélectionner une langue

v5.0,0615