

NPN Silicon Phototransistor

Type OP505W

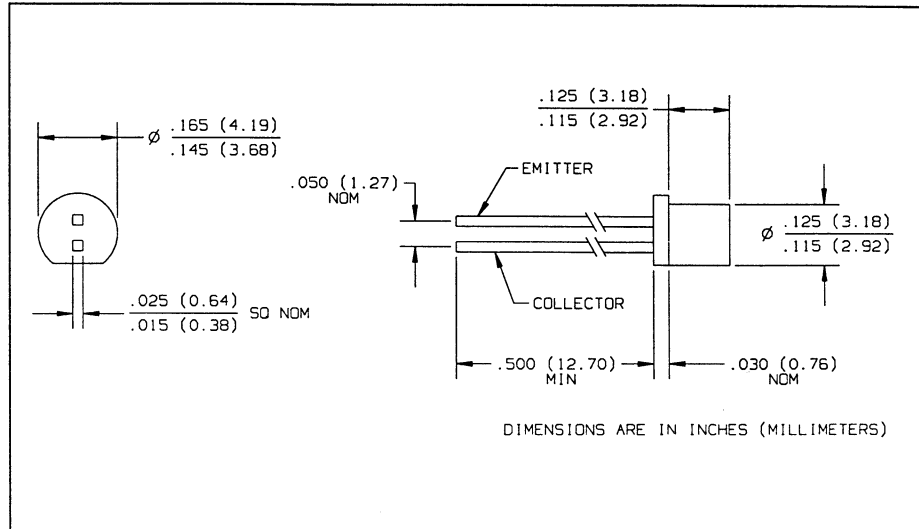
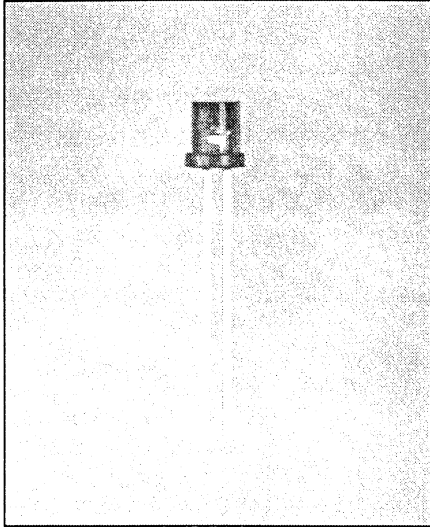

Features

- Wide receiving angle
- T-1 package style
- Small package size for space limited applications

Description

The OP505W consists of an NPN silicon phototransistor molded in a blue tinted plastic package. The wide receiving angle provides relatively even reception over a large area. This device is 100% production tested using infrared light for close correlation with Optek's GaAs and GaAlAs emitters.

Absolute Maximum Ratings ($T_A = 25^\circ\text{C}$ unless otherwise noted)

Collector-Emitter Voltage	30 V
Emitter-Collector Voltage	5.0 V
Storage and Operating Temperature Range	-40°C to $+100^\circ\text{C}$
Lead Soldering Temperature [1/16 inch (1.6 mm) from case for 5 sec. with soldering iron]	$260^\circ\text{C}^{(1)}$
Power Dissipation	100 mW ⁽²⁾

Notes:

- (1) RMA flux is recommended. Duration can be extended to 10 sec. max. when flow soldering. Max. 20 grams force may be applied to leads when soldering.
- (2) Derate linearly 1.33 mW/ $^\circ\text{C}$ above 25°C .
- (3) Light source is an unfiltered GaAs LED with a peak emission wavelength of 935 nm and a radiometric intensity level which varies less than 10% over the entire surface of the phototransistor being tested.
- (4) To calculate typical collector dark current in μA , use the formula $I_{CED} = 10^{(0.04 T_A - 3.4)}$ where T_A is ambient temperature in $^\circ\text{C}$.

Typical Performance Curves

Typical Spectral Response

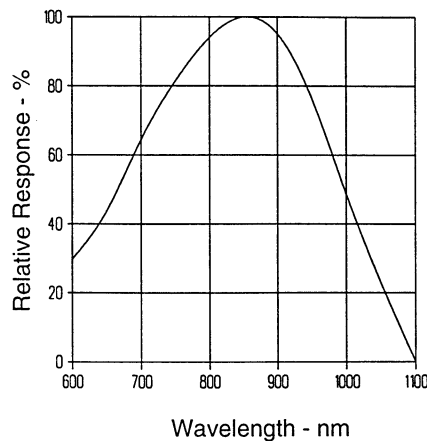

Coupling Characteristics of OP165W and OP505W

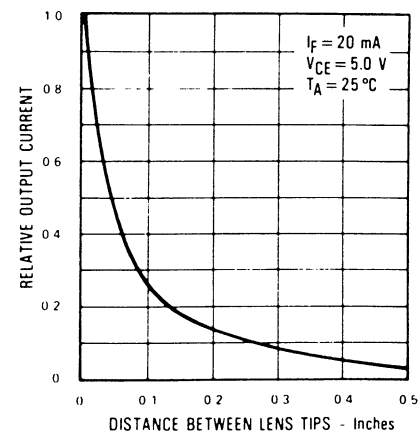

Types OP505W

Electrical Characteristics ($T_A = 25^\circ\text{C}$ unless otherwise noted)

SYMBOL	PARAMETERS	MIN	TYP	MAX	UNITS	TEST CONDITIONS
$I_{C(ON)}$	On-State Collector Current	100			μA	$V_{CE} = 5\text{ V}, E_e = 0.75\text{ mW/cm}^2(3)$
I_{CEO}	Collector Dark Current			100	nA	$V_{CE} = 10.0\text{ V}, E_e = 0$
$V_{(BR)CEO}$	Collector-Emitter Breakdown Voltage	30			V	$I_C = 100\ \mu\text{A}$
$V_{(BR)ECO}$	Emitter-Collector Breakdown Voltage	5.0			V	$I_E = 100\ \mu\text{A}$
$V_{CE(SAT)}$	Collector-Emitter Saturation Voltage			0.40	V	$I_C = 50\ \mu\text{A}, E_e = 0.75\text{ mW/cm}^2(3)$

Typical Performance Curves

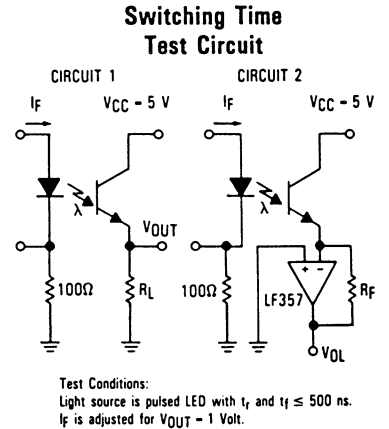
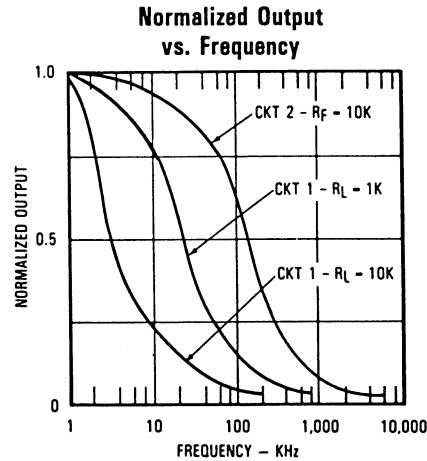
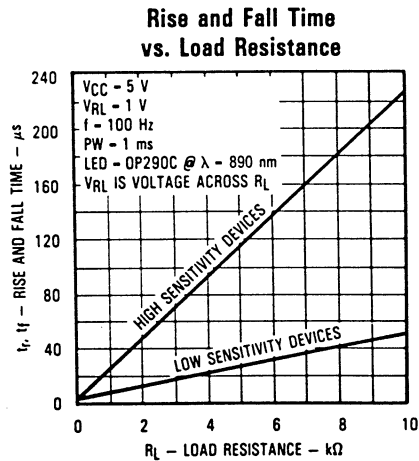
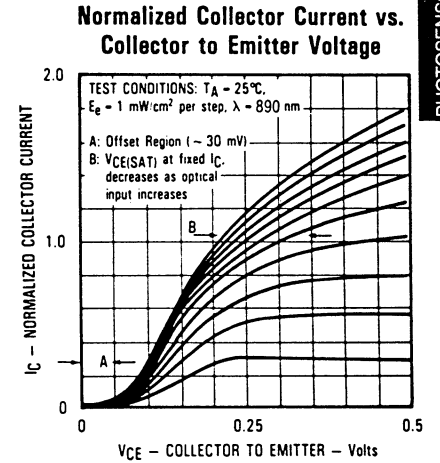
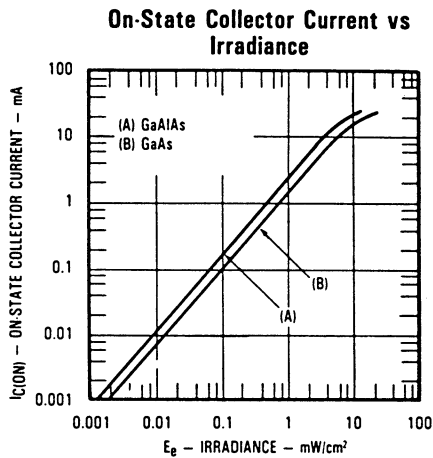
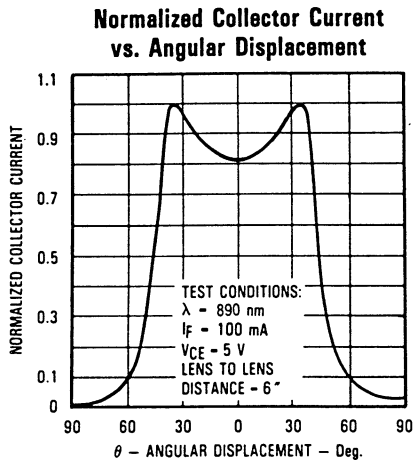

PHOTOSENSORS