

# Thick Film Chip Resistors

NRC Series

## FEATURES

- EIA STANDARD SIZING 01005(1/32W), 0201(1/20W), 0402(1/16W), 0603(1/10W), 0805(1/8W), 1206(1/4W), 1210(1/3W), 2010(3/4W) AND 2512(1W)
- METAL GLAZED THICK FILM ON HIGH PURITY ALUMINA SUBSTRATE (CERMET) PROVIDES UNIFORM QUALITY AND HIGH RELIABILITY
- DOUBLE GLASS OVERCOAT ASSURES STRONG MECHANICAL CONSTRUCTION AND LONG LIFE, NICKEL BARRIER PREVENTS LEACHING
- BOTH FLOW SOLDER AND REFLOW SOLDERING ARE APPLICABLE
- ZERO OHM (JUMPER) CHIP AND TRIMMABLE TYPE ARE AVAILABLE \*4

**NEW**  
**01005**  
**Case Sizes**



Type	EIA Size	Power Rating at 70°C	Max.*1 Working Voltage	Max.*2 Overload Voltage	Resistance Tolerance (Code)	Temperature Coefficient (ppm/°C)	Resistance Range (Ω)	Resistance Value	Operating Temperature Range (°C)
NRC01	01005	1/32 (0.031) W	15V	30V	±1% (F)	±300	10 ~ 91	E-24,E-96	-55 ~ +125
					±1% (F)	±200	100 ~ 1.62M	E-24,E-96	
					±5% (J)	+600/-200	1.0 ~ 9.1	E-24	
					±5% (J)	±300	10 ~ 91	E-24	
					±5% (J)	±200	100 ~ 10M	E-24	
NRC02	0201	1/20 (0.05) W	25V	50V	±1% (F)	+600/-200	1.0 ~ 9.96	E-24,E-96	-55 ~ +125
					±1% (F)	±200	10 ~ 10M	E-24,E-96	
					±5% (J)	+600/-200	1.0 ~ 9.1	E-24	
					±5% (J)	±200	10 ~ 10M	E-24	
					±10% (K)	±200	10 ~ 10M	E-12	
NRC04	0402	1/16 (0.063) W	50V	100V	±1% (F)	+500/-200	1.0 ~ 9.96	E-24,E-96	-55 ~ +155
					±1% (F)	±100	10 ~ 1M	E-24,E-96	
					±1% (F)	±300	1.02M ~ 10M	E-24,E-96	
					±5% (J)	±200	10 ~ 1M	E-24	
					±5% (J)	±350	1.0 ~ 9.1 & 1.1M ~ 10M *3	E-24	
NRC06	0603	1/10 (0.10) W	50V	100V	±1% (F)	±400	1.0 ~ 9.96	E-24,E-96	-55 ~ +155
					±1% (F)	±100	33.2 ~ 1M	E-24,E-96	
					±1% (F)	±200	10 ~ 32.4 & 1.1M ~ 10M *3	E-24,E-96	
					±5% (J)	±200	10 ~ 1M	E-24	
					±5% (J)	±350	1.0 ~ 9.1 & 1.1M ~ 10M *3	E-24	
NRC10	0805	1/8 (0.125) W	150V	300V	±1% (F)	±400	1.0 ~ 9.96	E-24,E-96	-55 ~ +155
					±1% (F)	±100	33.2 ~ 1M	E-24,E-96	
					±1% (F)	±200	10 ~ 32.4 & 1.1M ~ 10M *3	E-24,E-96	
					±5% (J)	±200	10 ~ 1M	E-24	
					±5% (J)	±350	1.0 ~ 9.1 & 1.1M ~ 10M *3	E-24	
NRC12	1206	1/4 (0.250) W	200V	400V	±1% (F)	±400	1.0 ~ 9.96	E-24,E-96	-55 ~ +155
					±1% (F)	±100	33.2 ~ 1M	E-24,E-96	
					±1% (F)	±200	10 ~ 32.4 & 1.1M ~ 10M *3	E-24,E-96	
					±5% (J)	±200	10 ~ 1M	E-24	
					±5% (J)	±350	1.0 ~ 9.1 & 1.1M ~ 10M *3	E-24	
NRC25	1210	1/3 (0.33) W	200V	400V	±1% (F)	±100	10 ~ 1M	E-24,E-96	-55 ~ +155
					±5% (J)	±200	10 ~ 1M	E-24	
					±5% (J)	±350	1.0 ~ 9.1 & 1.1M ~ 10M *3	E-24	
NRC50	2010	3/4 (0.75) W	200V	400V	±1% (F)	±100	10 ~ 1M	E-24,E-96	-55 ~ +155
					±5% (J)	±250	10 ~ 1M	E-24	
					±5% (J)	±350	1.0 ~ 9.1 & 1.1M ~ 10M *3	E-24	
NRC100	2512	1W	250V	500V	±1% (F)	±100	10 ~ 1M	E-24,E-96	-55 ~ +155
					±1% (F)	±250	2.0 ~ 9.76 *3		
					±1% (F)	±350	1.0 ~ 1.96 *3		
					±5% (J)	±250	10 ~ 1M	E-24	
					±5% (J)	±350	1.0 ~ 9.1 *3		
NRC01ZO	01005	Zero Ohm Jumper			Rated Current 0.5A (0.05Ω max. DC Resistance)			-55 ~ +125	
NRC02ZO	0201		Rated Current 0.5A (0.05Ω max. DC Resistance)						
NRC04ZO	0402		Rated Current 1.0A (0.05Ω max. DC Resistance)						
NRC06ZO	0603		Rated Current 1.0A (0.05Ω max. DC Resistance)			-55 ~ +155			
NRC10ZO	0805		Rated Current 2.0A (0.05Ω max. DC Resistance)						
NRC12ZO	1206		Rated Current 2.0A (0.05Ω max. DC Resistance)						
NRC25ZO	1210		Rated Current 2.0A (0.05Ω max. DC Resistance)						
NRC50ZO	2010		Rated Current 2.0A (0.05Ω max. DC Resistance)						
NRC100ZO	2512		Rated Current 2.0A (0.05Ω max. DC Resistance)						



Note \*1 - Maximum allowable continuous Working Voltage for all resistors is the lower of the two values: "Maximum Working Voltage" as specified above (or)

$$\sqrt{\text{Power rating (Watts)} \times \text{Resistance (Ohms)}}$$

Note \*2 - Maximum allowable Overload voltage is two times the Maximum Working Voltage (see Note \*1 above).

Note \*3 - Made to order. Contact NIC for leadtime.

Note \*4 - Please contact NIC for availability of laser trimmable versions of 0805 and 1206 sizes parts.

Note \*5 - Please note, NIC's NRC series products are capable of meeting the following specifications: JIS-C 5202, EIAJ RC-2690, EIA575, EIA PDP-100, MIL-R-5542D and UL94V-0.

**Power Derating Curve:** For operation above 70°C, power rating must be derated according to the following chart:

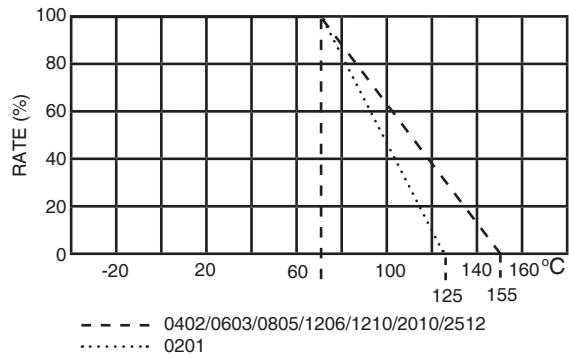

## DIMENSIONS (mm)

Type	Power Rating	EIA Size	L	W	H	T	t	
NRC01	1/32W	01005	0.40 ± 0.02	0.20 ± 0.02	0.13 ± 0.02	0.10 ± 0.03	0.10 ± 0.03	
NRC02	1/20W	0201	0.6 ± 0.03	0.3 ± 0.03	0.25 ± 0.05	0.1 ± 0.05	0.15 ± 0.05	
NRC04	1/16W	0402	1.0 +0.1/-0.05	0.5 +0.1/-0.05	0.3 ± 0.05	0.2 ± 0.1	0.25 ± 0.1	
NRC06	1/10W	0603	1.6 ± 0.15	0.8 ± 0.15	0.45 ± 0.1	0.3 ± 0.15	0.3 ± 0.15	
NRC10	1/8W	0805	2.0 ± 0.20	1.25 ± 0.10	0.5 ± 0.10	0.35 ± 0.20	0.35 ± 0.15	
NRC12	1/4W	1206	3.1 ± 0.15	1.55 ± 0.15	0.55 ± 0.10	0.45 ± 0.20	0.35 ± 0.15	
NRC25	1/3W	1210	3.1 ± 0.15	2.50 ± 0.20	0.55 ± 0.10	0.50 ± 0.20	0.50 ± 0.25	
NRC50	3/4W	2010	5.0 ± 0.20	2.50 ± 0.15	0.60 ± 0.10	0.60 ± 0.20	0.50 ± 0.30	
NRC100	1W	2512	6.3 ± 0.20	3.20 ± 0.20	0.60 ± 0.10	0.70 ± 0.20	0.70 ± 0.30	
NRC01ZO	JUMPER	01005	Same as NRC01					
NRC02ZO	JUMPER	0201	Same as NRC02					
NRC04ZO	JUMPER	0402	Same as NRC04					
NRC06ZO	JUMPER	0603	Same as NRC06					
NRC10ZO	JUMPER	0805	Same as NRC10					
NRC12ZO	JUMPER	1206	Same as NRC12					
NRC25ZO	JUMPER	1210	Same as NRC25					
NRC50ZO	JUMPER	2010	Same as NRC50					
NRC100ZO	JUMPER	2512	Same as NRC100					



## CONSTRUCTION

### NRC01 (01005)

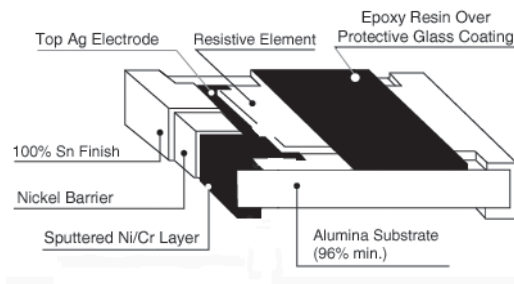

## CONSTRUCTION

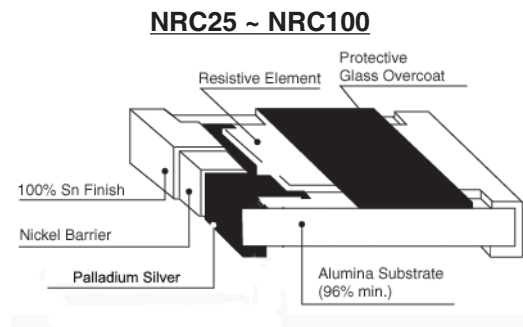
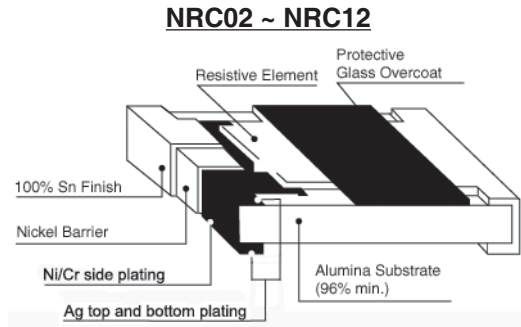

### PART NUMBER SYSTEM (E-24 VALUES)

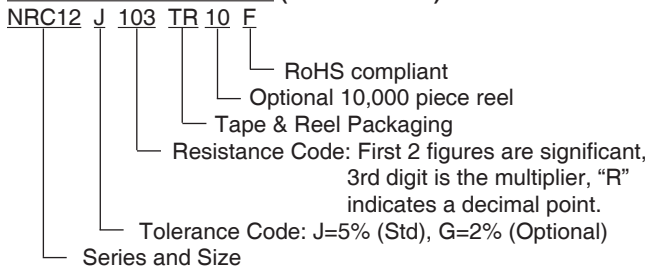

Examples of Resistance Code: 4R7 = 4.7 ohms    103 = 10K ohms  
 100 = 10 ohms    104 = 100K ohms  
 101 = 100 ohms    105 = 1 meg ohms  
 102 = 1K ohms    106 = 10meg ohms

### PART NUMBER SYSTEM (E-96 VALUES)

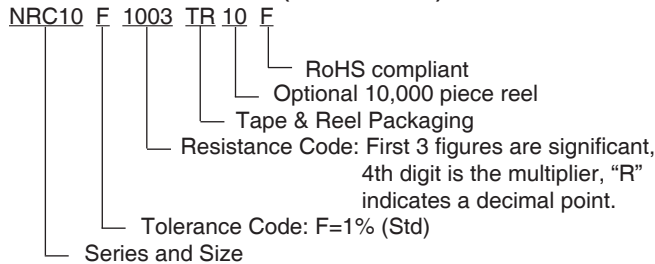

Examples of Resistance Code: 10R0 = 10 ohms    1004 = 1meg ohms  
 47R5 = 47.5 ohms    1050 = 105 ohms  
 1000 = 100 ohms    1501 = 1.5K ohms  
 1001 = 1K ohms    1052 = 10.5K ohms  
 1002 = 10K ohms    1153 = 115K ohms  
 1003 = 100K ohms    1214 = 1.21meg ohms

### Marking (No marking on 0201 and 0402 size).

1. For **E-12 & E-24** Series ( $\pm 1\% = F$ ,  $\pm 2\% = G$ ,  $\pm 5\% = J$ , (STD) Tolerance) in 0603, 0805, 1206, 1210, 2010 and 2512 sizes:
  - 3 DIGIT SYSTEM - First two digits are significant and third digit is multiplier, "R" indicates decimal on values under 10 ohms.
  - Examples: R10 = .10 ohms    1R0 = 1.0 ohms    102 = 1k ohms    470 = 47 ohms  
 103 = 10k ohms    101 = 100 ohms    104 = 100k ohms    105 = 1 megohms
2. For **E-96** Series ( $\pm 1\% - F$  Tolerance) in 0805, 1206 and 1210 sizes:
  - 4 DIGIT SYSTEM - First 3 digits are significant and fourth digit is multiplier, "R" indicates decimal on values under 100 ohms.
  - Examples: 0R10 = .10 ohms    1R00 = 1.0 ohms    10R0 = 10 ohms    1003 = 100 kohms  
 1000 = 100 ohms    1004 = 1 megohms    1001 = 1k ohms  
 1052 = 10.5k ohms    1002 = 10k ohms    2213 = 221k ohms
3. For **E-96** Series ( $\pm 1\% - F$  Tolerance) in 0603 size
  - 3 DIGIT SYSTEM (Due to space restrictions)



## STANDARD E-12, E-24, E-96 VALUES AND 0603 1% TOLERANCE RESISTANCE CODES

Note: 0603 1% resistor values that are exclusive to E-12 or E-24 (ex. 12K) are marked with the three character 5% tolerance code

E-12		E-24		E-96							
Value	Value	Value	Code	Value	Code	Value	Code	Value	Code	Value	Code
10	100	100	01	102	02	105	03	107	04		
12	110	110	05	113	06	115	07	118	08		
15	120	121	09	124	10	127	11	130	12		
18	130	133	13	137	14	140	15	143	16		
22	150	147	17	150	18	154	19	158	20		
27	160	162	21	165	22	169	23	174	24		
33	180	178	25	182	26	187	27	191	28		
39	200	196	29	200	30	205	31	210	32		
47	220	215	33	221	34	226	35	232	36		
56	240	237	37	243	38	249	39	255	40		
68	270	261	41	267	42	274	43	280	44		
82	300	287	45	294	46	301	47	309	48		
91	330	316	49	324	50	332	51	340	52		
	360	348	53	357	54	365	55	374	56		
	390	383	57	392	58	402	59	412	60		
	430	422	61	432	62	442	63	453	64		
	470	464	65	475	66	487	67	499	68		
	510	511	69	523	70	536	71	549	72		
	560	562	73	576	74	590	75	604	76		
	620	619	77	634	78	649	79	665	80		
	680	681	81	698	82	715	83	732	84		
	750	750	85	768	86	787	87	806	88		
	820	825	89	845	90	866	91	887	92		
	910	909	93	931	94	953	95	976	96		

### MULTIPLIER CODE

Code	A	B,b	C	D,d	E	F	G	H	X	Y	Z
Multiplier	10 <sup>0</sup>	10 <sup>1</sup>	10 <sup>2</sup>	10 <sup>3</sup>	10 <sup>4</sup>	10 <sup>5</sup>	10 <sup>6</sup>	10 <sup>7</sup>	10 <sup>-1</sup>	10 <sup>-2</sup>	10 <sup>-3</sup>

### CODING FORMULA

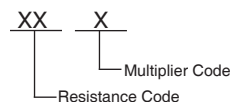

Example:  $10.2k\Omega = \frac{102}{02} \times 10^2 \Omega = 02C$

$33.2 \Omega = \frac{332}{51} \times 10^{-1} = 51X$

### MARKING EXAMPLES

10Ω = 01X  
 7.5kΩ = 85B or 85b  
 150kΩ = 18D or 18d  
 1 MegΩ = 01E

### 0603 1% E-12/E-24 Values

160Ω = 161  
 12KΩ = 123  
 8.2MΩ = 825

## TAPING SPECIFICATIONS

### (1) Availability

Type	Power Rating	EIA Size	Carrier Tape			Qty per 7" Reel	Qty per 10" Reel
			Fig.	Material	Width (mm)		
NRC01	1/32W	01005	A	Paper	8	20,000	N/A
NRC02	1/20W	0201	A	Paper	8	10,000	N/A
NRC04	1/16W	0402	A	Paper	8	10,000	N/A
NRC06	1/10W	0603	A	Paper	8	5,000	10,000
NRC10	1/8W	0805	A	Paper	8	5,000	10,000
NRC12	1/4W	1206	A	Paper	8	5,000	10,000
NRC25	1/3W	1210	B	Plastic	12	4,000	N/A
NRC04ZO	Jumper	0402	A	Paper	8	10,000	N/A
NRC06ZO	Jumper	0603	A	Paper	8	5,000	10,000
NRC10ZO	Jumper	0805	A	Paper	8	5,000	10,000
NRC12ZO	Jumper	1206	A	Paper	8	5,000	10,000
NRC25ZO	Jumper	1210	B	Plastic	12	4,000	N/A



## (2) PAPER TAPE DIMENSIONS (mm)

**FIG. A**

Type	EIA Size	A	B	D	E	F	P <sub>0</sub>	P <sub>1</sub>	P <sub>2</sub>	P <sub>3</sub>	T <sub>1</sub>	T <sub>2</sub>	W
NRC01*	01005	0.25 ± 0.05	0.45 ± 0.05	1.5 + 0.1	1.75 ± 0.1	3.5 ± 0.05	4.0 ± 0.1	2.0 ± 0.05	N/A	2.0 ± 0.05	0.39 max.	0.31 ± 0.03	8.0 ± 0.2
NRC02*	0201	0.41 ± 0.1	0.71 ± 0.1					2.0 ± 0.1		2.0 ± 0.1			
NRC04*	0402	0.65 ± 0.1	1.15 ± 0.1					2.0 ± 0.05		2.0 ± 0.05			
NRC06*	0603	1.135 ± 0.05	1.95 ± 0.05					N/A	4.0 ± 0.05	4.0 ± 0.05	1.1 max.	1.0 max.	
NRC10*	0805	1.65 ± 0.2	2.4 ± 0.2										
NRC12*	1206	2.0 ± 0.2	3.6 ± 0.2										

\* Same for JUMPER (ZO) types.

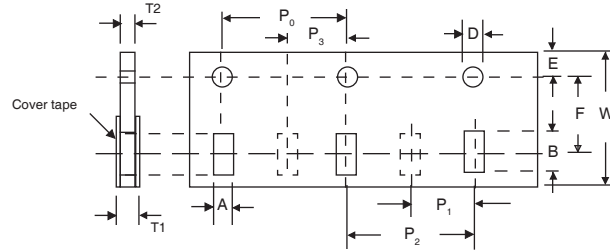

## (3) EMBOSSED PLASTIC TAPE SPECIFICATION

**FIG. B.**

Type	EIA Size	A	B	D	E	F	P <sub>0</sub>	P <sub>1</sub>	W	Qty per 7" Reel
NRC25*	1210	2.9 ± 0.2	3.6 ± 0.2	1.5 ± 0.1	1.5 ± 0.1	5.65 ± 0.05	4.0 ± 0.1	4.0 ± 0.05	12.0 ± 0.1	4,000
NRC50*	2010	2.9 ± 0.1	5.4 ± 0.1							4,000
NRC100*	2512	3.6 ± 0.1	6.9 ± 0.1							4,000

\* Same for JUMPER (ZO) types.

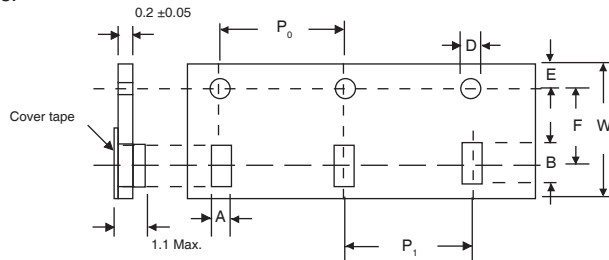

## (4) REEL SPECIFICATIONS

**FIG. C.**

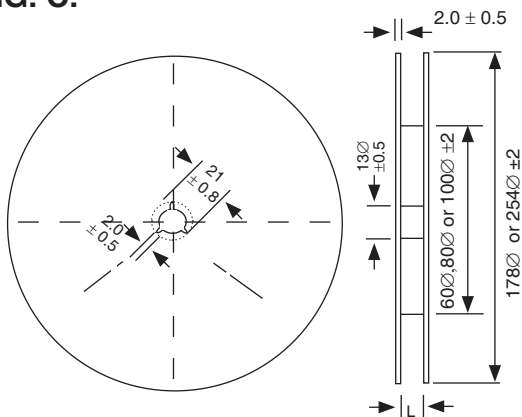

1. Leader tape : Approximately 250 m/m (160mm for 0201 case size) leader shall be provided at each end of the tape.

2. Accumulative tolerance of feeding hole and chip pocket shall not exceed 0.2mm over 10 pitches.

Type	EIA Size	L (mm)
NRC01*	01005	9.0 ± 0.3
NRC02*	0201	10.0 ± 1.5
NRC04*	0402	10.0 ± 1.5
NRC06*	0603	10.0 ± 1.5
NRC10*	0805	10.0 ± 1.5
NRC12*	1206	10.0 ± 1.5
NRC25	1210	10.0 ± 1.5
NRC50	2010	13.5 ± 1.5
NRC100*	2512	13.5 ± 1.5

\* Same for JUMPER (ZO) types.



## PAPER CARRIER DIMENSIONS (mm)

Type	EIA Size	A	B	D	E	F	P <sub>0</sub>	P <sub>1</sub>	P <sub>2</sub>	T	W	Quantity/Reel
NRC04	0402	0.7±0.5	1.2±0.05	1.5+0.1/-0	1.75±0.1	3.5±0.05	4.0±0.1	2.0±0.05	2.0±0.05	0.45±0.1	8.0±0.2	30,000 pieces

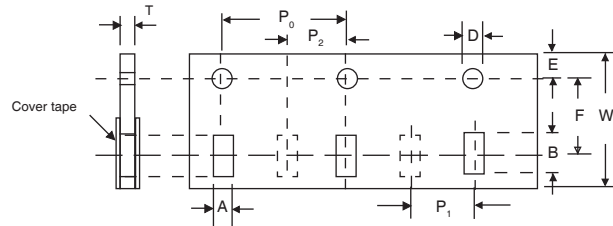

## REEL DIMENSIONS (mm)

